

COLLECTORS NO. 41210
WINDOW

ASSEMBLY AND
FINISHING INSTRUCTIONS

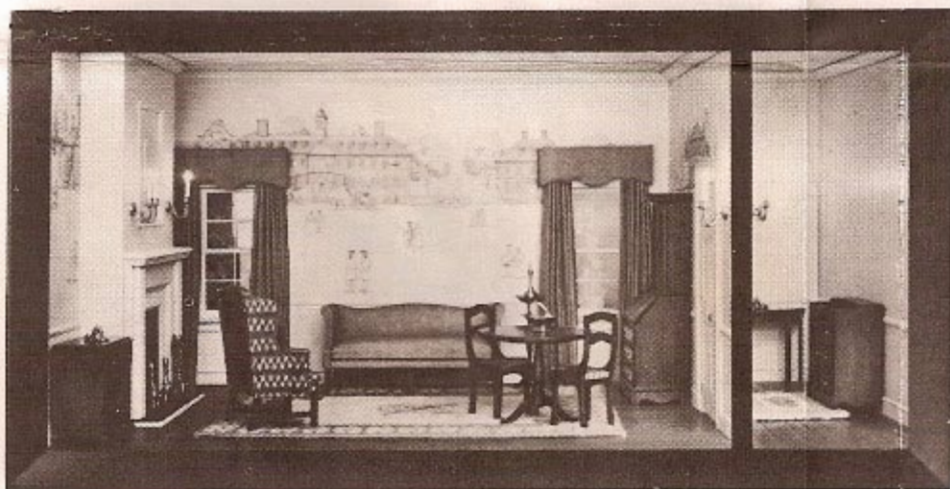

AUTHENTIC REPRODUCTIONS IN MINIATURE



The X-ACTO® House of Miniatures® Collectors Series of furniture and accessories have all been carefully researched by specialists through major museum and library collections to assure the highest quality of authenticity in reproduction. Details are extraordinarily accurate to satisfy the most discriminating miniaturist.

Every item in the line is an authentic reproduction in miniature of regular-size furniture created by master craftsmen during the Colonial period, precision scaled, one inch to one foot.

All wood parts are machined to assure accurate and precise acceptance of each piece by another.

The rooms illustrated have been completed using standard X-ACTO® HOUSE OF MINIATURES products. All individual components are available.



For a complete catalog of the X-ACTO® HOUSE OF MINIATURES furniture line and accessories, write to:

THE HOUSE OF MINIATURES
Customer Service - Catalog Dept.
80 Newbridge Road
Bergenfield, NJ 07621

X-ACTO®

INTRODUCTION

INSTRUCTIONS BEFORE STARTING

before starting

Identify and account for each part by placing it on the **LAYOUT SHEET** (page 2). This will indicate, at a glance, whether any parts are missing. **(See instructions at bottom of last sheet to order missing parts.)**

sanding

NOTE: When using sandpaper, remember that the higher the grit number, the finer the finish.

A. One sanding method that has proved successful is the use of a sanding platform. Tape a sheet of sandpaper of the proper grit size to a hard flat surface such as a table top or wood block. Press down **lightly** and move the piece to be sanded **in the same direction** as the wood grain until the surface is smooth. **Take care not to round any edges or corners of the pieces.**

B. Before assembly, sand all the outer surfaces of individual parts with 220 grit sandpaper, or finer, paying particular attention to edges that will be exposed after assembly.

gluing

A. Glue should be applied in small amounts to both surfaces being joined. On end cuts, it may be necessary to apply a second coat of glue before joining the parts.

B. To ensure a tight fit, squeeze excess glue out of the joints by holding glued parts together with either clamps, rubber bands or by placing weights on the parts.

C. Wipe off excess glue promptly with a damp cloth.

D. Be sure a glued assembly has dried thoroughly before adding any more parts.

tools and materials

A. The following tools **will be helpful** in constructing this kit:

1. Knife, X-ACTO No. 1, with Blade, X-ACTO No. 11
2. Tweezer, X-ACTO No. 36
3. One-inch Sander X-ACTO No. 41
4. Large Clamp, X-ACTO No. 4004
5. Small Clamp, X-ACTO No. 4003
6. Power Sprayer, X-ACTO No. 43561

B. The following materials **will be needed** to construct this kit:

1. Straight pins or artist's push pins
2. Waxed paper
3. Sandpaper — 220 or finer
4. Ruler
5. Paint of your choice
6. White glue, or any good wood glue
7. Small artist's brush

LAYOUT SHEET

FRAME ASSEMBLY

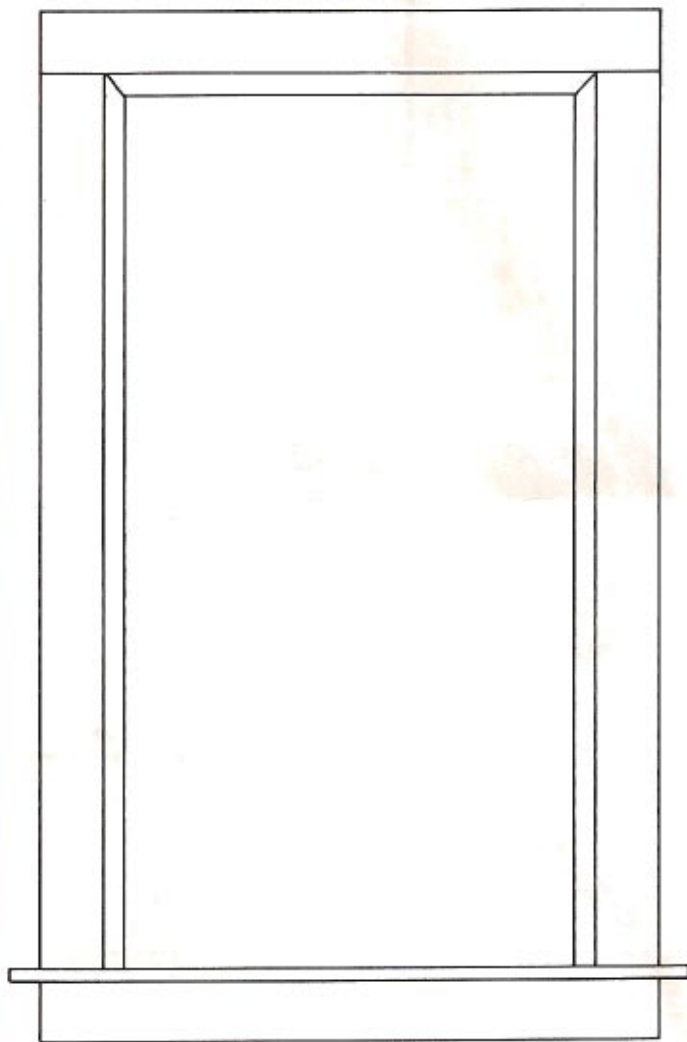

3 (2 REQ'D)



2 (2 REQ'D)



8 (5 REQ'D)



4



9 (2 REQ'D)



5 (4 REQ'D)



6



1



45° CHAMFER
(BOTH ENDS)

7 (2 REQ'D)
(CLEAR PLASTIC)

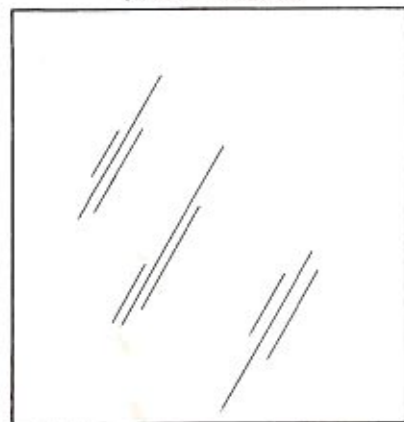

DETAIL VIEWS

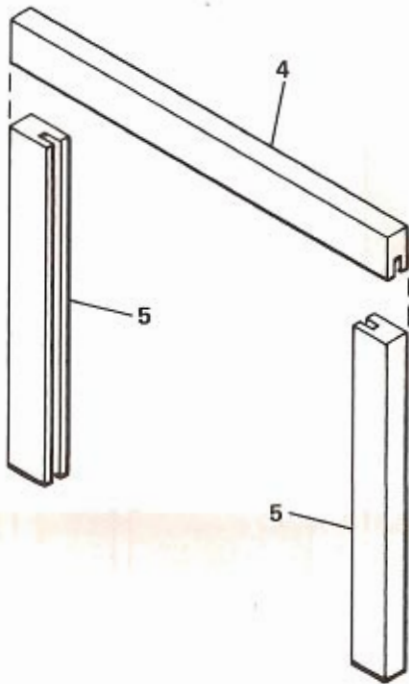

DETAIL A UPPER WINDOW

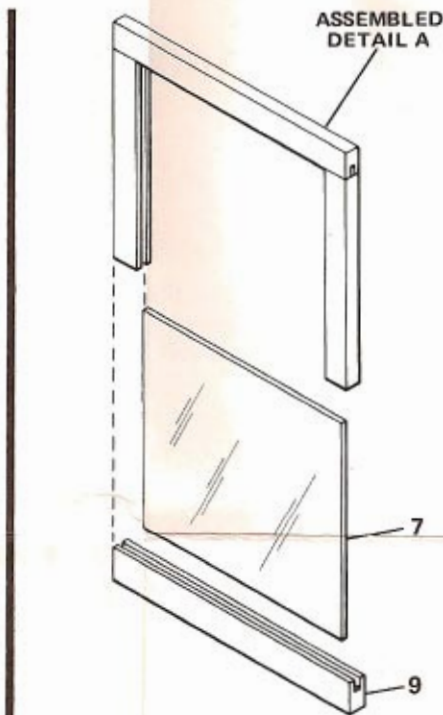

DETAIL B UPPER WINDOW

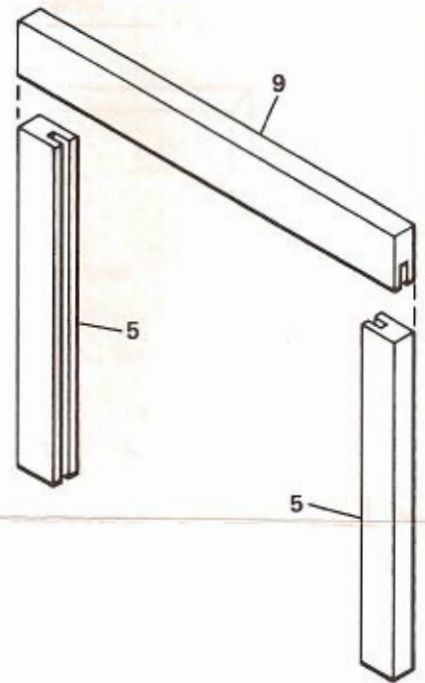

DETAIL C LOWER WINDOW

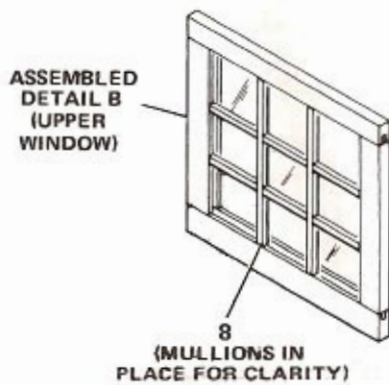

8
(MULLIONS IN PLACE FOR CLARITY)

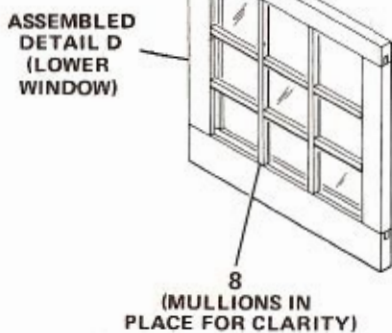

8
(MULLIONS IN PLACE FOR CLARITY)

DETAIL E

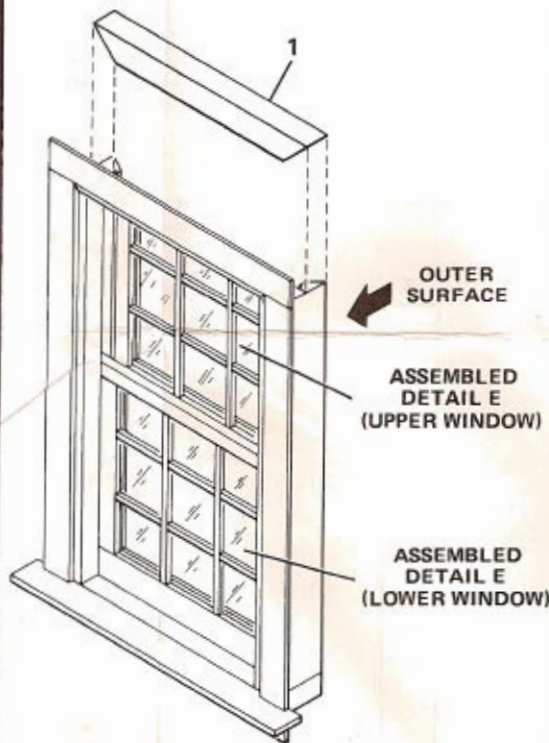

DETAIL F

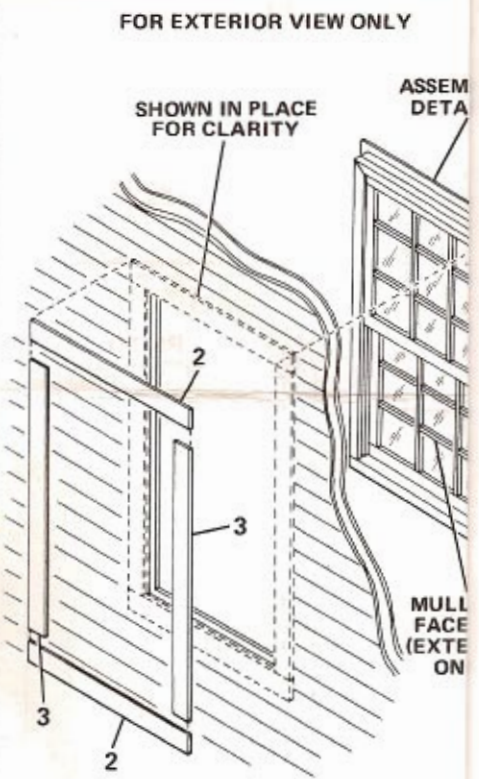

DETAIL G (OPTIONAL)

ASSEMBLY

- A. Before starting to assemble your kit, study all illustrations and instructions carefully. Be certain you understand each step before proceeding to the next one.
- B. Follow the sequence of steps in the order they are presented. **Do not skip steps or take any short cuts.**
- C. Refer to **ALIGNMENT** (page 5) for patterns to be used to align the frame for gluing. When gluing parts together, use a flat toothpick or similar tool to apply a small amount of glue to the parts to be joined. Remove any excess glue promptly with a damp cloth. **Remember to let each glued assembly dry thoroughly before adding the next part.**
- D. Begin assembly of the **upper window** (see **DETAIL A**, page 3) as follows:
1. Glue top of window frame (part no. 4) to two sides (parts no. 5).
 2. Align parts face down on alignment **pattern no. 1** (see **ALIGNMENT**, page 5).
 3. Hold parts in place until glue sets. (Follow instructions for the glue being used for the proper setting time.)

E. Complete assembly of the **upper window** (see **DETAIL B**, page 3) as follows:

NOTE: When painting assembled **DETAIL A** and window bottom (part no. 9) avoid paint accumulation in slots for plastic window (part no. 7).

1. Lightly sand assembled **DETAIL A** and window bottom (part no. 9).
2. Moisten a cloth slightly and rub the dampened cloth over the entire wood surface to remove all particles.
3. When all signs of moisture have gone from the wood, paint with a high quality paint of your choice.

NOTE: All parts must be completely dry before proceeding.

4. Insert plastic window (part no. 7) into assembled **DETAIL A**. **Do not glue.**
5. Glue bottom of window frame (part no. 9) to assembled **DETAIL A**.

F. Begin assembly of the **lower window** (see **DETAIL C**, page 3) as follows:

1. Glue top of window frame (part no. 9) to two sides (parts no. 5).
2. Align parts face down on alignment **pattern no. 1** (see **ALIGNMENT**, page 5).
3. Hold parts in place until glue sets.

G. Complete assembly of the **lower window** (see **DETAIL D**, page 3) as follows:

NOTE: When painting assembled **DETAIL C**, and window bottom (part no. 6) avoid paint accumulation in slots for plastic window (part no. 7).

1. Lightly sand assembled **DETAIL C** and window bottom (part no. 6).
2. Moisten a cloth slightly and rub the dampened cloth over the entire wood surface to remove all particles.
3. When all signs of moisture have gone from the wood, paint with a high quality paint of your choice.

NOTE: All parts must be completely dry before proceeding.

4. Insert plastic window (part no. 7) into assembled **DETAIL C**. **Do not glue.**
5. Glue bottom of window frame (part no. 6) to assembled **DETAIL C**.

H. Assemble **mullions** (see **DETAIL E**, page 3) as follows:

NOTE:

- a. After mullions are painted, stand vertically and allow to dry.
- b. Use a toothpick to deposit small amounts of glue on ends of mullions only. **Do not glue entire surface of mullion.**
- c. When gluing mullions to windows be sure of position before placing on plastic window as any sliding action may deposit unwanted glue on plastic window surface.

1. Paint mullions (parts no. 8) with a high quality paint of your choice.

NOTE: All mullions must be completely dry before proceeding.

2. Place assembled **DETAIL B** face down on alignment **pattern no. 2** (see **ALIGNMENT**, page 5).

NOTE: For precision work, place entire mullion on surface of window and align with alignment pattern below. Cut and glue piece by piece allowing each mullion to dry before proceeding. When gluing use the alignment pattern for exact locations.

3. Cut and glue mullions to **upper window** (assembled **DETAIL B**) as shown in **pattern no. 2** (see **ALIGNMENT**, page 5).
4. Repeat steps 1 and 2 for lower window (assembled **DETAIL C**).
5. Hold parts in place until glue sets.

I. Prepare frame for assembly (see **DETAIL F**, page 3) as follows:

NOTE: When painting frame **do not** paint window tracks as this will restrict window operation.

1. Lightly sand frame and cross support (part no. 1).
2. Moisten a cloth slightly and rub the dampened cloth over the entire wood surface to remove all particles.
3. When all signs of moisture have gone from the wood, paint with a high quality paint of your choice.

NOTE: a. All parts must be completely dry before proceeding.

b. The hobbyist must now decide whether the window will have an exterior view or interior view. For exterior viewed windows the mullion side of the window should face the outside surface. For interior viewed windows the mullion side should face the interior (sill side).

c. The hobbyist may find it necessary to sand the outer surface of the mullions to ensure proper window operation.

4. Install lower window (assembled **DETAIL E**) into main frame assembly.
5. Install upper window (assembled **DETAIL E**) into main frame assembly.
6. Glue cross support (part no. 1) to main frame assembly.

J. **(OPTIONAL)** (EXTERIOR EXPOSURE ONLY). Assemble **outside frame** (see **DETAIL G**, page 3) as follows:

NOTE: Outside frame assembly is to be glued to an exterior exposure wall first, then the window (assembled **DETAIL F**) should be installed and glued to the frame assembly.

1. Glue top and bottom of outside frame assembly (parts no. 2) to two sides (parts no. 3).
2. Align parts face down on alignment **pattern no. 3** (see **ALIGNMENT**, page 5).
3. Hold parts in place until glue sets.
4. Lightly sand outside frame assembly.
5. Moisten a cloth slightly and rub the dampened cloth over the entire wood surface to remove all particles.
6. When all signs of moisture have gone from the wood, paint with a high quality paint of your choice.

NOTE: All parts must be completely dry before proceeding.

7. Glue assembled outside frame to an outside exposure wall.
8. Glue assembled **DETAIL F** to the installed outside frame assembly.

K. You have now completed assembly of your window. The completed piece should look like that shown in **DETAIL H**.

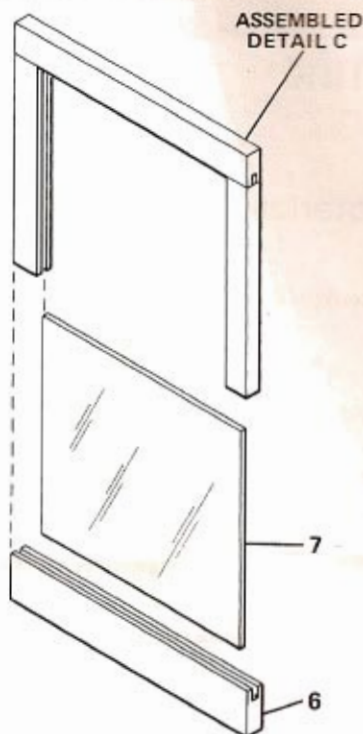

DETAIL D LOWER WINDOW



FINAL ASSEMBLY (INSIDE VIEW)



FINAL ASSEMBLY (OPTIONAL OUTSIDE VIEW)

DETAIL H

ALIGNMENT

PATTERN 1

(USE FOR EITHER UPPER WINDOW (PART NO. 4)
OR LOWER WINDOW (PART NO. 9))

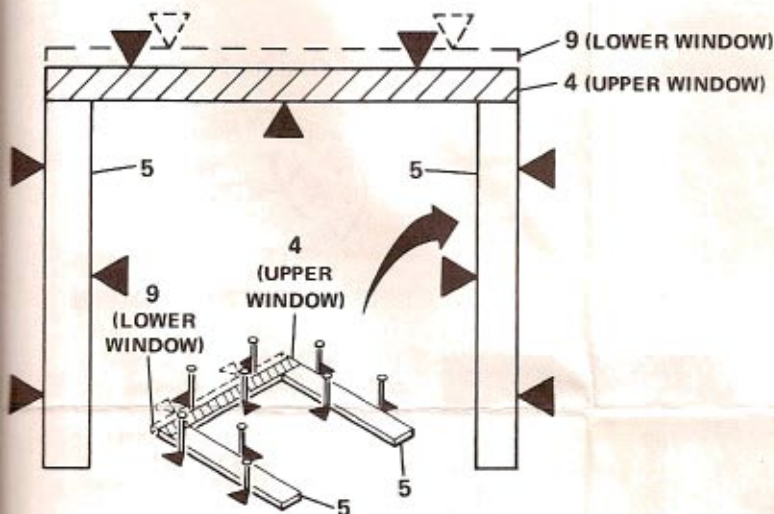

PATTERN 2

(USE FOR EITHER UPPER WINDOW (PART NO'S. 4 & 6)
OR LOWER WINDOW (PART NO'S. 6 & 9))

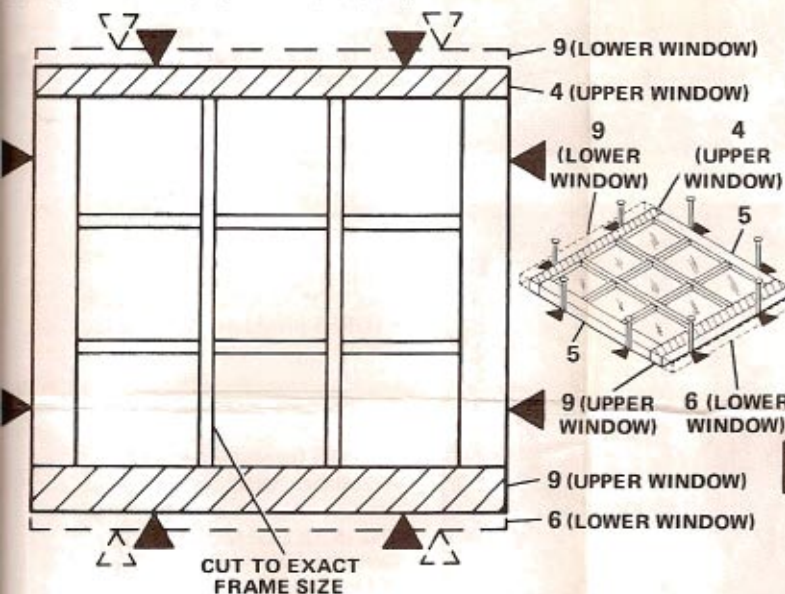

alignment patterns

A. Tape this sheet to a smooth, flat surface. Then tape sheet of waxed paper to the pattern so that any excess glue at the joint will not stick to the pattern, making it difficult to remove the completed assembly.

B. Use the alignment patterns shown here to position the indicated parts properly and to hold them in alignment while drying. The arrowheads show the points to insert the straight pins to properly secure the parts.

PATTERN 3

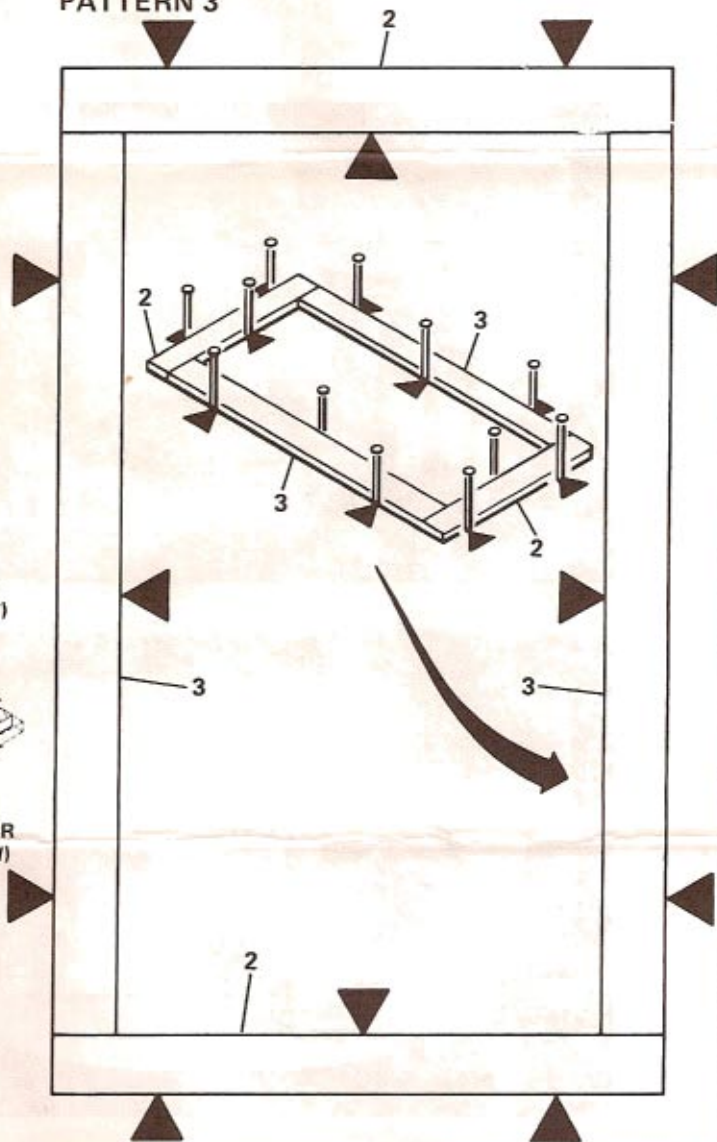

Every effort has been made to insure the completeness of this KIT—however, should any parts be missing, write directly to:

THE HOUSE OF MINIATURES
Customer Service - Parts Dept.
2000 Craftmark Center
Statesville, NC 28677-2000



AUTHENTIC REPRODUCTIONS IN MINIATURE

When ordering missing parts, please Print your name and address plainly. State the missing PART NO. (See LAYOUT SHEET, page 2), KIT NO. 41210 and the Kit Name, "WINDOW".